

# Data Sheet



Article number: 12511600020500  
Description: KLEE-coil 511 600 020.500  
M2 Stainless 1.4305

## Measures

---

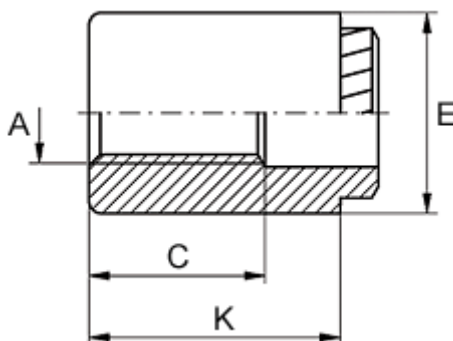

Female thread A	= M2
Height K	= 11
Hole diameter +0.1	= 3.7
Min distance to edge	= 2.2
Min material thickness	= 1.5
Outer diameter E	= 6
Thread length	= 9